



6 VARI 500 floor/
wall distribution

VARI 500

WALL-/FLOOR DISTRIBUTION CABINET

The high degree of flexibility and simple but extremely versatile assembly possibilities are distinguishing factors of the VARI 500 enclosure range from apraNET. Ease of assembly and installation allows you to keep to your budget and to your timescales when managing your networking project. Suitable for all types of installation, either wall, stand-alone or a three-piece wall swing enclosure. The VARI 500 range will live up to all your expectations. As a direct result of our experience and your require-

ments, apraNET has even specified several standard models in this range of enclosures. You can of course configure your own enclosure if you wish. You order the individual components and then receive a tailored-made assembled enclosure: please contact us should you have any further requirements. We will be only too glad to provide you with any advice and will make up your own custom part.





500 • 19" wall enclosure **VARI 500**



Complete solutions:



3 part 19" wall enclosure

Note: Please order cable flange plates separately!

Delivery:

- wall mounted enclosure
- basic enclosure
- viewing door with turning lever lock
- vertical mountings
- "Vari 500" lock
- M 5 screw set (4-fold)

wall enclosure VARI 500, 3 part

- wall distribution enclosure with pivoting mid section 400mm deep and internal lock for wall mounted enclosure
- 19" level in the front
- viewing door toughened safety glass with turning lever lock for profile half cylinder
- 19" set of screws M5, 50 pcs
- four cutouts for individual fixing of cable flange plates

Dimensions:

(H x W x D): H x 600 mm x 590 mm

Finish: RAL 7035 light grey

Material: sheet metal

Delivery: mounted in cardboardbox

H (mm)	U	D (mm)	Order no.
350	6	590	50-0201-06
500	9	590	50-0201-09
600	12	590	50-0201-12
750	15	590	50-0201-15
900	18	590	50-0201-18
1150	24	590	50-0201-24



2 part 19" wall enclosure

Note: Please order cable flange plates separately!

Delivery:

- basic enclosure
- viewing door with turning lever lock
- rear panel
- wall bracket set
- vertical mountings
- M 5 screw set (4-fold)

19" wall enclosure VARI 500, 2 part

- 400mm basic enclosure
- 19" level in the front
- viewing door toughened safety glass with turning lever lock for profile half cylinder
- detachable rear panel
- angled wall brackets, included
- two cutouts for individual fixing of cable flange plates
- 19" set of screws M5, 50 pcs

Dimensions: (H x W x D):

H x 600 mm x 400 mm

Finish: RAL 7035 light grey

Material: sheet metal

Delivery: mounted in cardboardbox

H (mm)	U	D (mm)	Order no.
350	6	400	50-0202-06
500	9	400	50-0202-09
600	12	400	50-0202-12
750	15	400	50-0202-15
900	18	400	50-0202-18
1150	24	400	50-0202-24



19" floor distribution cabinet **VARI 500** • 500

19" floor distribution cabinet Preferential type 24U

- 19" sheet metal floor distribution cabinet with following dimensions:
H = 1250 mm, W = 600 mm, D = 600 mm
- viewing front door with turning lever bar lock for profile half cylinder
- rear door closed
- two cutouts for individual fixing of cable flange plates
- 24U 19" level front depth adjustable
- cable entry base H = 100mm with detachable panels allround
- 19" set of screws M5, 50 pcs

Finish:

RAL 7035 light grey

Material: sheet metal

Delivery: mounted

Please refer to page 6.4 ff. for other sizes in custom configurations

Order number
50-0000-60

Note: Please order cable flange plates separately!



6 VARI 500 floor/
wall distribution

VARI 500 "cool-box" 24 U

- 19" sheet metal floor distribution cabinet with following dimensions:
H = 1700 mm, W = 600 mm, D = 800 mm
- viewing front door with turning lever bar lock for profile half cylinder
- rear door closed
- cut-out in bottom covered by foam rubber up to cable entry
- 24U 19" level front and rear depth adjustable
- cable entry base H = 100mm with detachable panels allround
- top mounted cooling unit (performance 410 W)

Finish: RAL 7035 light grey

Material: sheet metal

Delivery: mounted

Order number
50-0000-89





500 • 19" wall enclosure **VARI 500**



Custom configuration:

Configure your own wall enclosure. Select the required enclosure components step by step.

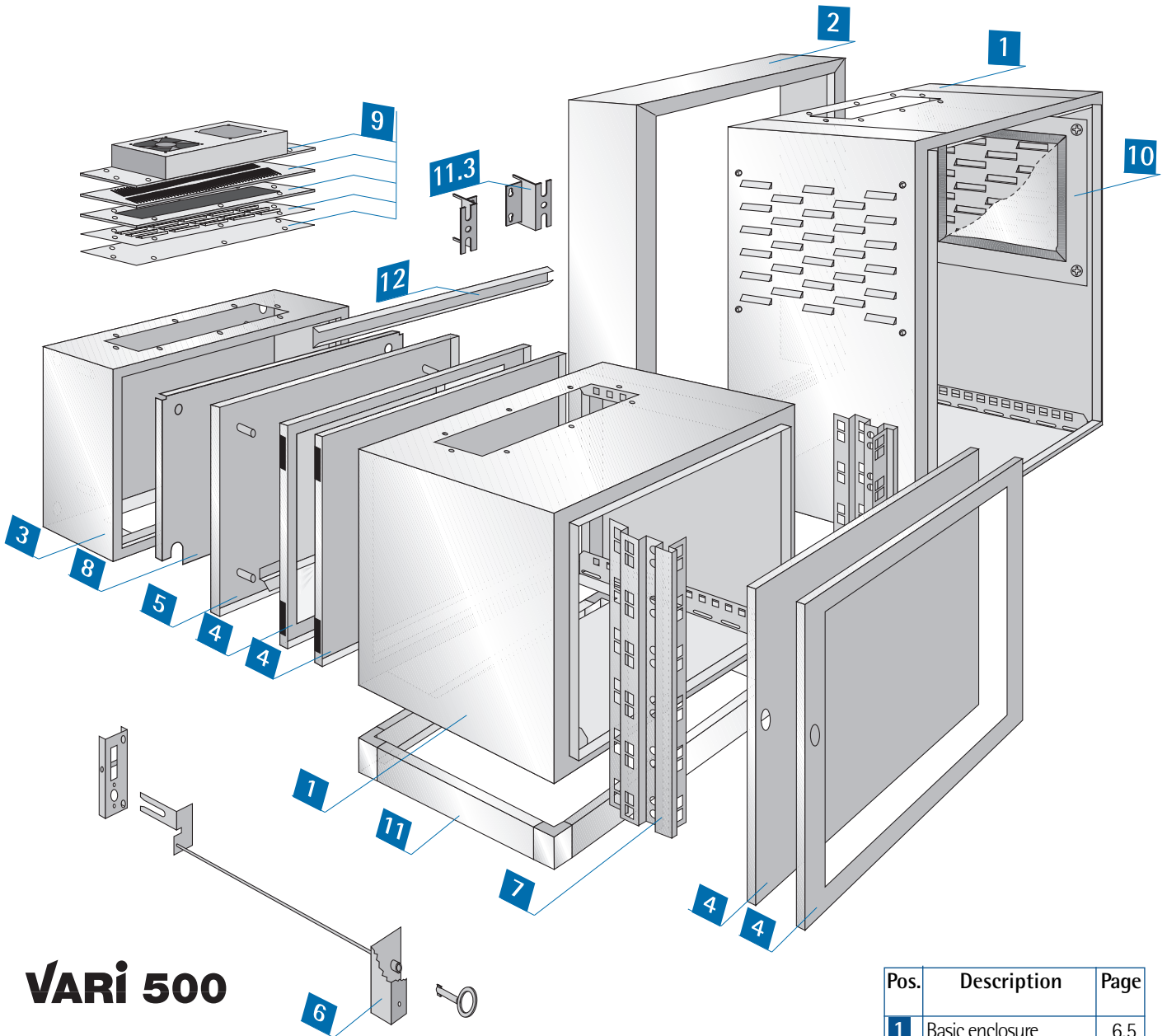

VARI 500

Note:
the maximum vertical mounting distance between two levels is D=40mm. Please take this measurement into account when choosing distribution enclosure.

Pos.	Description	Page
1	Basic enclosure	6.5
2	Supplement frame	6.5
3	Wall mounted enclosure	6.5
4	Doors	6.5
5	Rear panel	6.5
6	Locking system	6.5
7	19" extension	6.6
8	Mounting plate	6.6
9	Cable flange plates/ set of brushes	6.6
10	Cover plate for venti- lated grill field	6.6
11	Base	6.6
11.3	Wall bracket set	6.6
12	Cabling retainer bars	6.7



1 Basic enclosure - closed

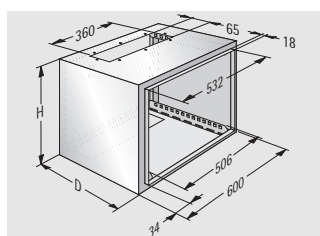

- with cable entry top and bottom

Finish:

RAL 7035 light grey

Depth (D)mm	Height (H)mm	Order number
400	350	50-0062-00
	500	50-0092-00
	600	50-0122-00
600*	350	50-0063-00
	500	50-0093-00
	600	50-0123-00

4 Viewing door with toughened safety glass

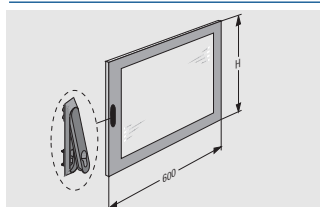

- turning lever lock for profile half cylinder (profile half cylinder see below)

Finish:

RAL 7035 light grey

Height (H) mm	Order number
350	50-0005-00
500	50-0008-00
600	50-0011-00
750	50-0014-00
900	50-0017-00
1150	50-0023-00

Profile half cylinder

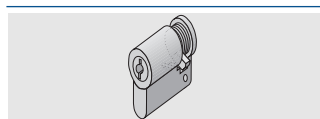

- for later integration into turning lever lock of the viewing door

Delivery: 1 profile half cylinder, complete with keys

Order number
676-062

1 Base enclosure - ventilated

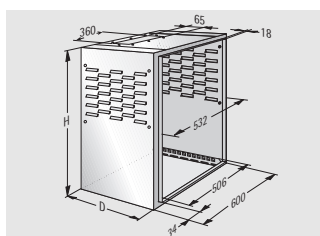

- with cable entry top and bottom

Finish:

RAL 7035 light grey

Depth (D)mm	Height (H)mm	Order number
400	750	50-0152-00
	900	50-0182-00
	1150	50-0242-00
600*	750	50-0153-00
	900	50-0183-00
	1150	50-0243-00

4 Door - closed

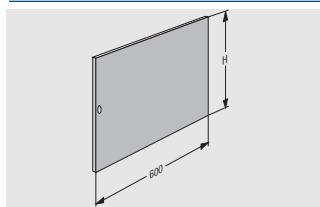

- sash fastener locking mechanism
- 2 locks from H=600mm

Finish:

RAL 7035 light grey

Height (H) mm	Order number
350	50-0007-00
500	50-0010-00
600	50-0013-00
750	50-0016-00
900	50-0019-00
1150	50-0025-00

Spare key

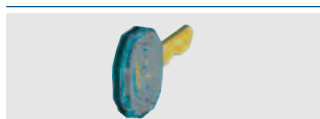

- for profile half cylinder or sash fastener
- lock Ek 333

Order number
676-200

2 Supplement frame

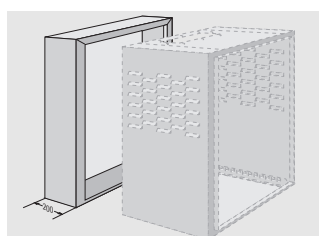

- for increasing depth of basic enclosures to D=800 mm

Finish:

RAL 7035 light grey

Height (H) mm	Order number
350	50-0061-00
500	50-0091-00
600	50-0121-00
750	50-0151-00
900	50-0181-00
1150	50-0241-00

5 Rear panel

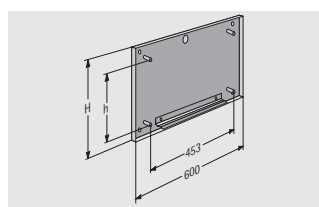

Finish:

RAL 7035 light grey

Height (H)mm	h mm	Order number
350	200	50-0226-00
500	350	50-0229-00
600	450	50-0232-00
750	600	50-0235-00
900	750	50-0238-00
1150	1000	50-0244-00

Toggle sash fastener



- for profile key lock
- appropriate for the door-closed and rear panel

Order number
676-197

3 Wall mounted enclosure

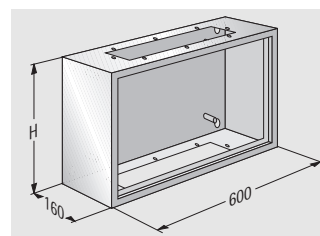

- 160mm deep for assembly of a three-part swing enclosure

Note:

the wall mounted enclosure is **only** combinable with a 400mm deep basic enclosure

Finish:

RAL 7035 light grey

Height (H) mm	Order number
350	50-0060-00
500	50-0090-00
600	50-0120-00
750	50-0150-00
900	50-0180-00
1150	50-0240-00

6 Loking system for 3 part enclosure (basic enclosure with wall mounted enclosure)

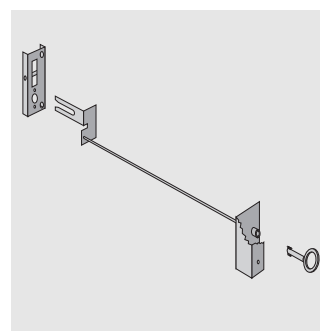

Attention: 2 locking mechanisms are required from H=600mm

Finish:

zinc coated and blue passivated

D = depth of the basic enclosure

Depth(D) mm	Order number
400	676-362

* These basic enclosures cannot be combined with a wall mounted enclosure.



500 • 19" wall enclosure **VARI 500**



7 19" Vertical mounting

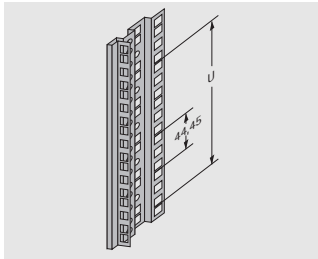

- adjustable in 25mm grid increments towards rear
 - including mounting hardware
 - ASA (1/2 19") perforation
- Finish:** zinc coated

Height (H)mm	U	Order number
350	6	500-306
500	9	500-309
600	12	500-312
750	15	500-315
900	18	500-318
1150	24	500-324

8 Mounting plate

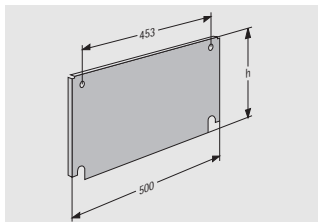

Finish: zinc coated

Height (H)mm	hmm	Order number
350	230	500-106
500	380	500-109
600	480	500-112
750	630	500-115
900	780	500-118
1150	1030	500-124

11.1 Set of rollers



- for screwing to the basic enclosure
- 4 guide rollers with rear hole (two with stop brake)

Load capacity: 250 kg

Description	Order no.
Set of rollers, H=105 mm	50-0330-10

9 Cable flange plate - closed

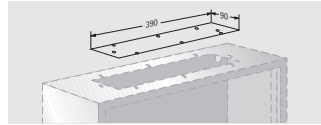

- on request with custom cutouts
- including mounting hardware

Finish:

RAL 7035 light grey

Order number
50-0131-00

9 Vent plate passive ventilation



- including mounting hardware

Finish:

RAL 7035 light grey

Order number
50-0132-00

10 Cover plate for basic enclosure - ventilated

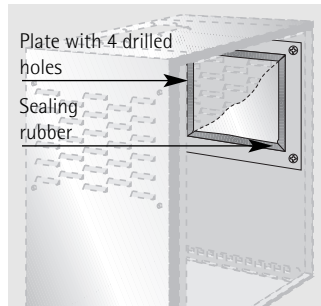

- with rubber gasket, self-adhesive

Finish: zinc coated

Order number
50-0024-10

11.2 4 Adjusting feet

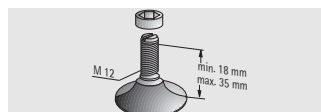

- for screwing to the basic enclosure
- comprising 4 adjusting feet
- adjustm.t range: approx. 20 mm
- including mounting hardware

Order number (Set)
50-0550-00

9 Set of brushes for flange plates opening

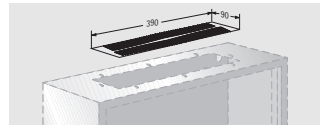

- including mounting hardware

Finish:

RAL 7035 light grey

Order number
50-0133-00

9 Cable plate with rubber inset

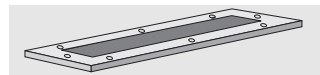

- including mounting hardware

Finish:

RAL 7035 light grey

Order number
50-0095-00

10.1 Filter set for vent. grill field basic encl. - ventilated

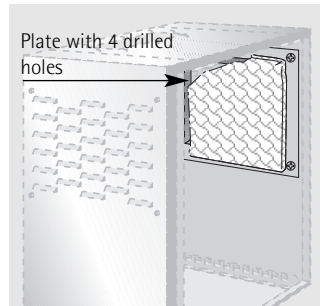

- with rubber gasket, self-adhesive

Finish: zinc coated

Order number
50-0822-00

11.3 Wall bracket set for basic/wall mounted enclosure

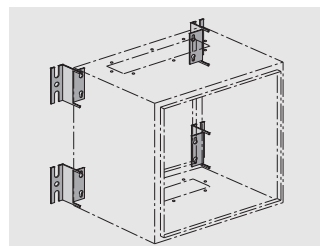

- The wall bracket set allows wall mounting of the basic enclosure and the wall mounted enclosure

9 Ventilation unit active ventilation

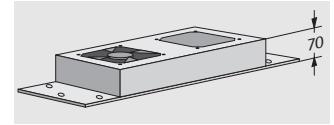

This ventilation unit is screwed on to the upper cable entry cutout. It is wired with a fan on a connection terminal, ready for connection. **The thermostat is integrated.**

The fan is covered with a protective grid on one side. Fan flow rate: 160 m³/h

Finish:

RAL 7035 light grey

Description	Order no.
Ventilation unit	50-0698-10
appropriate fans	230-804

11 Base

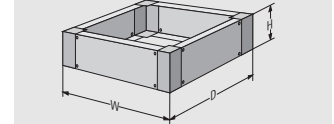

- stable screwed construction
- panels detachable, allowing simple grinding of cabling
- stackable

Finish:

RAL 7035 light grey

Height (H)mm	Depth (D)mm	Order number
100	400	50-0327-10
100	600	50-0327-00
100	800	50-0327-20

Delivery:

4 brackets with screws, nuts and washers

Finish: zinc coated

Note:

Not combinable with door!

Order number
500-099



12 Cable retainer bars

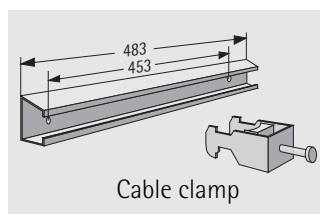

- for traverse integration at rear

Please order cable clamps separately!

Finish: zinc coated

Order number
500-100

Cable clamp

Cable diameter	Order number
∅ 8-12	640-132
∅ 12-16	640-133
∅ 16-22	640-134

12.1 Cable management bracket

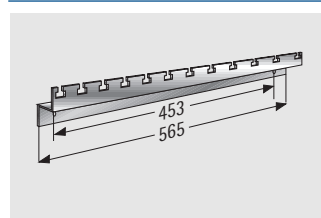

- for bundling and strain-relief of cables with cable ties
- for traverse integration at rear
- including mounting hardware

Finish:
RAL 7035 light grey

Order number
315-800

13 Vertical strut

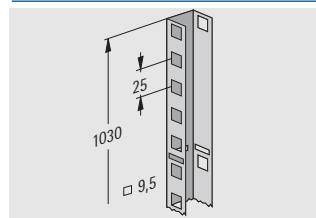

- for wall mounted enclosure or rear panel
- for height adjustable attachment of cable retainer bars

Note: The vertical strut has to be shortened to the correct enclosure height.

Finish:
zinc coated

Order number
50-0100-03

14 Slide rails for basic enclosure

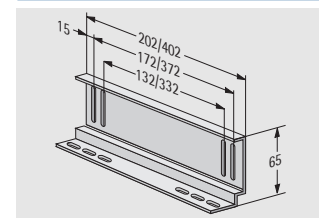

Slide rails are mounted on the 19" vertical mountings to support heavy 19" plug-in units. Two 19" levels are required for attachment.

Material/Finish:

sheet metal 2 mm, zinc coated

Load capacity: 50 kg

Enclosure depth (D) mm	Order number (pair)
400	312-543
600	312-544

14.1 19" shelf fixed

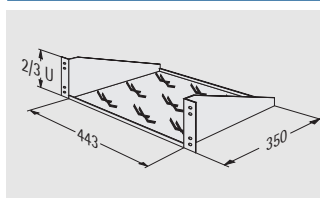

- easy mounting to 19" level
- ventilated
- including mounting hardware

Load capacity : ca. 15 kg

Finish:
RAL 7035 light grey

Height	Order number
2 U	31-5810-20
3 U	31-5810-00

14.2 19" shelf

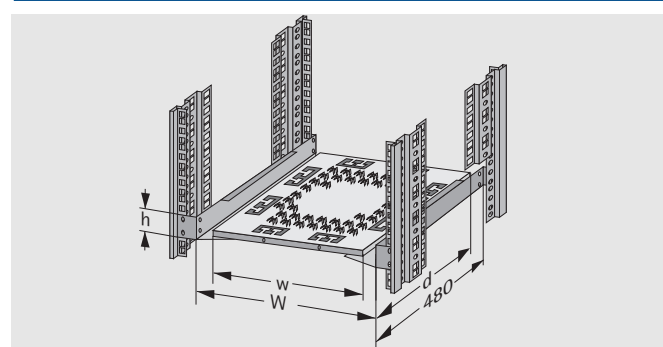

- this 19"-shelf requires a second 19" level
- with sliding kit pos. 14.3 combinable
- only usable for D = 600mm

Finish:
RAL 7035 light grey

U	W	Footprint w x d x h	Function	Capacity	Order no.
1	19"	415x475x88	fixed	50	31-6036-19

14.3 Pull-out set for shelf

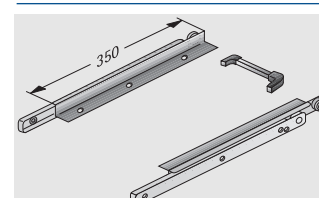

The 1U shelf can be made telescopic by using this sliding kit.

Finish:
zinc coated

Order number
68-0051-10

15 19" set of screws M5 / M6

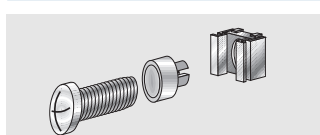

- 50 cage-nuts M 5/ M 6
- 50 decorative washers M5/M6 with collar
- 50 oval head screws M 5 x 12/M 6 x 16

Description	Order no.
M 5	630-991
M 6	630-994

16 Earthing set

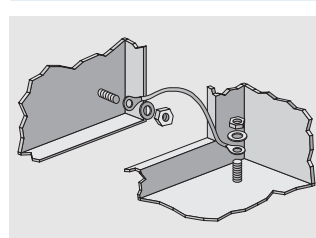

- the set provides VDE compliant earthing of the enclosure parts
- cable ∅ 2.5 mm²

Order number
50-0840-00



Visions become reality...



Standard cabinet combination

- based on the Vari 500 enclosure system



**Mobile server cabinet
Depth 900mm**



**Control cabinet for
industrial applications**